

EVlink

Pro AC Charging Stations

Troubleshooting Guide

Highly reliable and smart charging stations for an increased efficiency and sustainability

DOCA0282EN-00
07/2023



Legal Information

The Schneider Electric brand and any trademarks of Schneider Electric SE and its subsidiaries referred to in this guide are the property of Schneider Electric SE or its subsidiaries. All other brands may be trademarks of their respective owners.

This guide and its content are protected under applicable copyright laws and furnished for informational use only. No part of this guide may be reproduced or transmitted in any form or by any means (electronic, mechanical, photocopying, recording, or otherwise), for any purpose, without the prior written permission of Schneider Electric.

Schneider Electric does not grant any right or license for commercial use of the guide or its content, except for a non-exclusive and personal license to consult it on an "as is" basis. Schneider Electric products and equipment should be installed, operated, serviced, and maintained only by qualified personnel.

As standards, specifications, and designs change from time to time, information contained in this guide may be subject to change without notice.

To the extent permitted by applicable law, no responsibility or liability is assumed by Schneider Electric and its subsidiaries for any errors or omissions in the informational content of this material or consequences arising out of or resulting from the use of the information contained herein.

As part of a group of responsible, inclusive companies, we are updating our communications that contain non-inclusive terminology. Until we complete this process, however, our content may still contain standardized industry terms that may be deemed inappropriate by our customers.

Table of Contents

Safety Information.....	5
About the Book.....	6
Introduction	8
Example of System Installation With EVlink Pro AC Charging Stations	8
List of Tools.....	9
EVlink Pro AC Description.....	10
EVlink Pro AC	10
EVlink Pro AC Metal	10
EVlink Pro AC Identification	11
Exterior View.....	12
Socket With Shutters T2S	13
Domestic Socket	13
Inside View	14
Status Indicator Light	15
Electric Vehicle Troubleshooting	16
Electric Vehicle Does Not Charge on Domestic Socket	16
Electric Vehicle Does Not Charge on T2S Socket.....	17
Electric Vehicle Charges Too Slowly.....	18
Electric Vehicle Presence Input Does Not Work	18
Electric Vehicle Cannot be Disconnected From T2S Socket	19
EVlink Pro AC Troubleshooting	20
EVlink Pro AC Indicator Light is Off	20
EVlink Pro AC Indicator Light is Red	23
Diagnostic Report.....	24
Vendor Error Codes.....	25
Procedure for Each Error Code.....	26
eSetup Troubleshooting.....	29
eSetup Presentation	29
Connection to the Charging Station.....	29
I Cannot See the Charging Station on eSetup	30
I Have a Problem With the Password	30
I Have a Problem With the Admin Badge	31
I Cannot Record Badges With eSetup	31
I Have a Problem With the User Badge	31
Glossary	33

Safety Information

Important Information

Read these instructions carefully, and look at the equipment to become familiar with the device before trying to install, operate, service, or maintain it. The following special messages may appear throughout this documentation or on the equipment to warn of potential hazards or to call attention to information that clarifies or simplifies a procedure.



The addition of this symbol to a "Danger" or "Warning" safety label indicates that an electrical hazard exists which will result in personal injury if the instructions are not followed.



This is the safety alert symbol. It is used to alert you to potential personal injury hazards. Obey all safety messages that follow this symbol to avoid possible injury or death.

DANGER

DANGER indicates a hazardous situation which, if not avoided, **will result in** death or serious injury.

WARNING

WARNING indicates a hazardous situation which, if not avoided, **could result in** death or serious injury.

CAUTION

CAUTION indicates a hazardous situation which, if not avoided, **could result in** minor or moderate injury.

NOTICE

NOTICE is used to address practices not related to physical injury.

Please Note

Electrical equipment should be installed, operated, serviced, and maintained only by qualified personnel. No responsibility is assumed by Schneider Electric for any consequences arising out of the use of this material.

A qualified person is one who has skills and knowledge related to the construction and operation of electrical equipment and its installation, and has received safety training to recognize and avoid the hazards involved.

About the Book

EVlink Master Range

EVlink is the Schneider Electric range of eMobility solutions with electric vehicle (EV) charging stations, EV Energy Management Software, and EV Field Services. eMobility solutions can be used in a full range of applications such as residential, buildings, and fleets that enable driving to a net-zero future.

Document Scope

This document provides you with information to guide you in troubleshooting of an EVlink Pro AC charging station and an EVlink Pro AC Metal charging station.

This document tells you how to:

- carry out first level troubleshooting without eSetup app.
- carry out second level troubleshooting with eSetup app connected to the charging station.
- restore the factory settings of the charging station.

This document is intended for commissioning technicians, electrical contractors and site operators.

Validity Note

This document applies to EVlink Pro AC and Pro AC Metal charging stations.

Online Information

The technical characteristics of the devices described in this guide also appear online. To access the information online, go to the Schneider Electric home page at www.se.com.

The information contained in this guide is likely to be updated at any time. Schneider Electric strongly recommends that you have the most recent and up-to-date version available on www.se.com/ww/en/download.

Related Documents

The documentation related to the Pro AC charging stations is the following:

Title of documentation	Reference number
EVlink Pro AC - Installation Guide	NNZ1940301
EVlink Pro AC - Spare Part Replacement Guide	GEX2273501
EVlink Pro AC - Spare part replacement guide for standards	GEX4591201
EVlink Pro AC - OCPP Protocol Connectivity Guide	GEX1969200
EVlink Pro AC - Modbus Connectivity Guide	GEX1969300
Video showing how to diagnose an EVlink Pro AC issue with eSetup	How to diagnose an EVlink Pro AC issue with eSetup

The documentation related to the Pro AC Metal charging stations is the following:

Title of documentation	Reference number
EVlink Pro AC Metal wall-mounted charging station with 1 charge point - Installation Guide	JYT24399
EVlink Pro AC Metal floor-standing charging station with 2 charge points - Installation Guide	JYT24397
Video showing how to install and wire two charge point EVlink Pro AC Metal	How to install and wire two charge point EVlink Pro AC Metal
Electrical diagram EVlink Pro AC Metal	GEX2008001

The documentation related to the Pro AC charging stations with an Eichrecht meter is the following:

Title of documentation	Reference number
EVlink Pro AC Eichrecht - User Guide	DOCA0287EN & DE
EVlink Pro AC Eichrecht - Installation Guide	PKR12258

You can download these technical publications and other technical information from our website at www.se.com/ww/en/download.

Trademark

QR Code is a registered trademark of DENSO WAVE INCORPORATED in Japan and other countries.

Introduction

The troubleshooting of the Pro AC charging station is done in the following infrastructure.

Example of System Installation With EVlink Pro AC Charging Stations

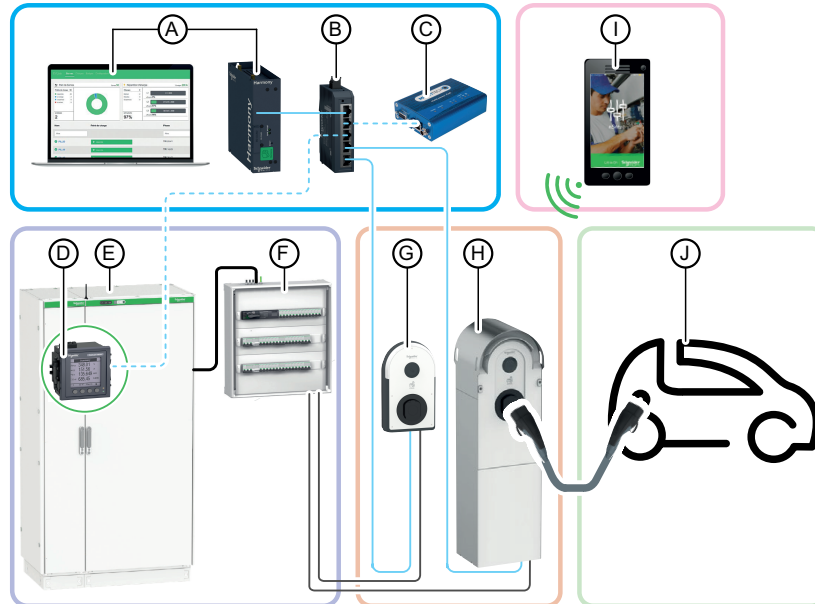

- A. EcoStruxure EV Charging Expert (energy management)
- B. Switch IT
- C. 3G/4G exterior modem (option)
- D. Power meter
- E. Main panel board
- F. EV divisional distribution panel board
- G. EVlink Pro AC
- H. EVlink Pro AC Metal
- I. eSetup smartphone application
- J. Electric Vehicle

List of Tools

To carry out the troubleshooting of an EVlink Pro AC charging station and an EVlink Pro AC Metal charging station, you need the following tools:

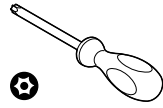

T20 Security
x 100 mm

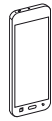

Smartphone



eSetup
application -
Google store



eSetup
application -
Apple store



Admin badge

For EVlink Pro AC Metal Charging Station Only

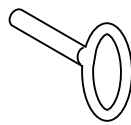

Special key to open the EVlink Pro AC Metal charging station

EVlink Pro AC Description

EVlink Pro AC

EVlink Pro AC is an AC power system for electric vehicles.

There are three types of Pro AC charging stations:

- Charging stations with a T2S socket
- Charging stations with an attached cable
- Charging stations with a T2S socket and a domestic socket



EVlink Pro AC Metal

The EVlink Pro AC Metal charging station is assembled with the following components:

- A metal kit enclosure:
 - wall mounted for 1 charge point, or
 - floor standing for 1 charge point, or
 - floor standing for 2 charge points.
- EVlink Pro AC charger to be installed inside the metal enclosure.
- Optional: Kaedra enclosure and/or Thalassa enclosure to be mounted inside the metal enclosure(s) for hosting the electrical protections.



EVlink Pro AC Identification

The industrial identification label of EVlink Pro AC is located at the side of the charging station.

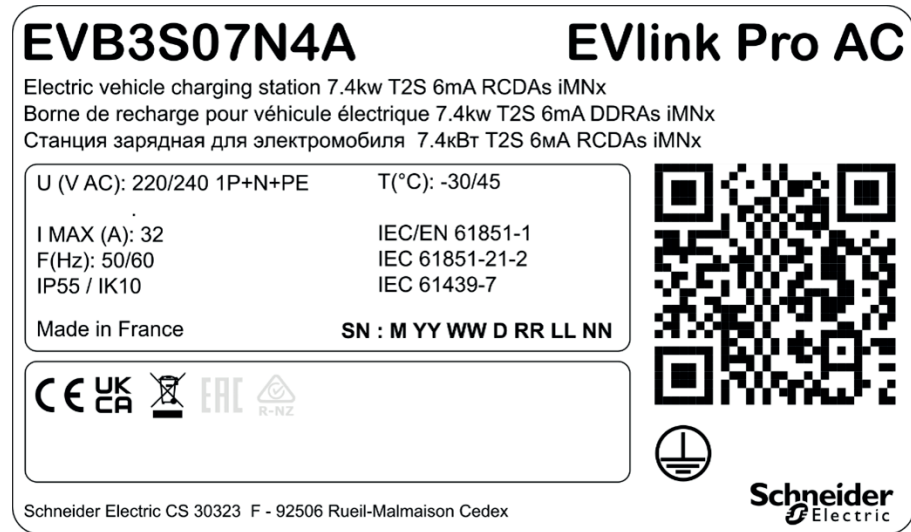

It indicates the serial number (**SN**) and the commercial part number (**EVB3 xxx**).

The serial number is coded M_YY_WW_D_RR_LL_NN, where:

- M: Manufacture plant and production line code
- YY: Year of the manufacture
- WW: Week of the manufacture
- D: Day of the week of manufacture (Monday =1)
- RR: Revision of the charging station
- LL: Production batch number
- NN: Unique production batch number

For example, R22045040123 means that update 04 of charging station 23 of batch 01 was manufactured at plant R on Friday 28 January 2022.

When the QR code on the identification label is scanned with a smartphone running a QR code reader and connected to the Internet, the Go2SE landing page is displayed. The landing page gives access to charging station characteristics and documentation.

Exterior View

The following graphic describes the charging station exterior.

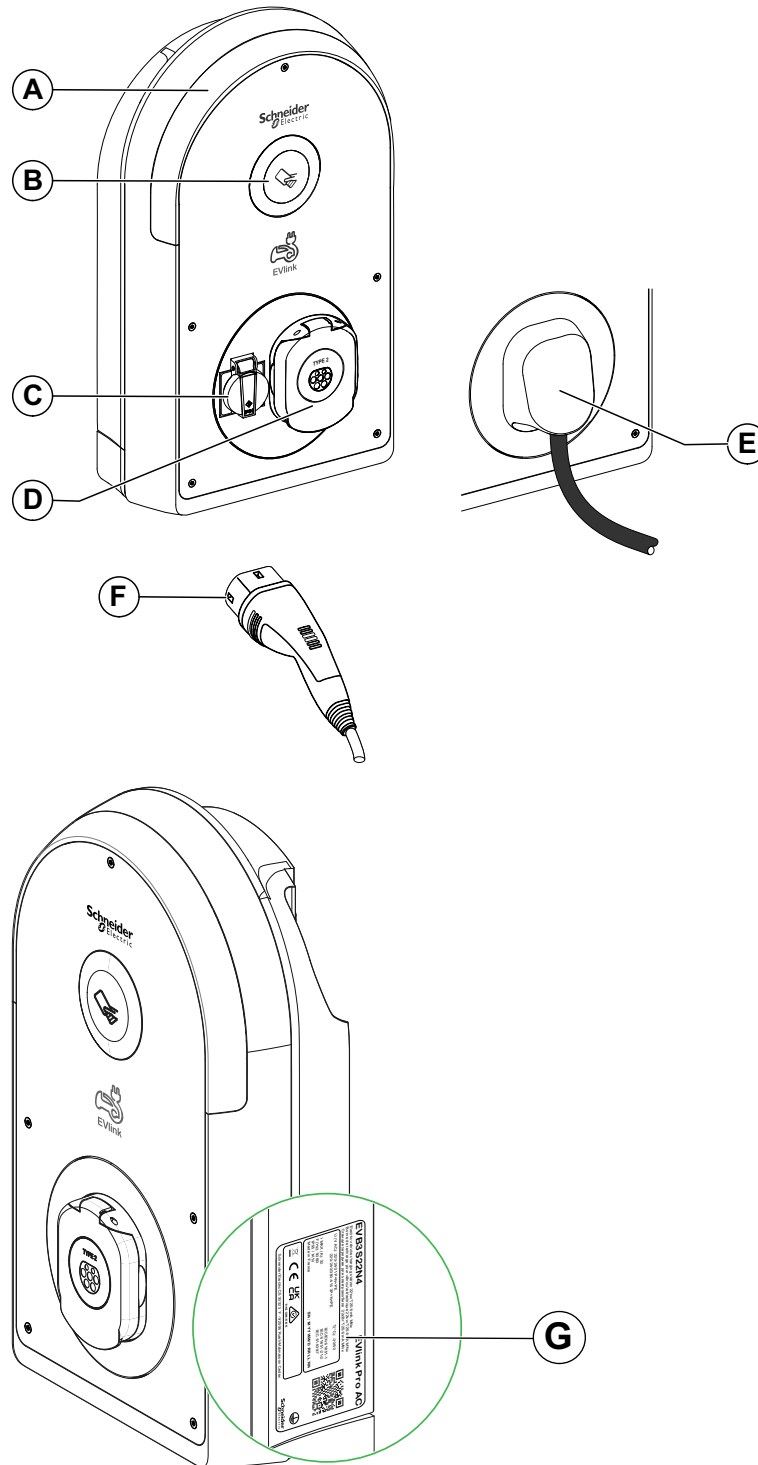

- A. Status indicator light
- B. RFID / NFC reader
- C. Domestic socket (TE or TF type)
- D. Socket with shutters T2S
- E. 5 m attached cable
- F. T2 vehicle connector
- G. Identification label

Socket With Shutters T2S

The following graphic describes the socket with shutters T2S.

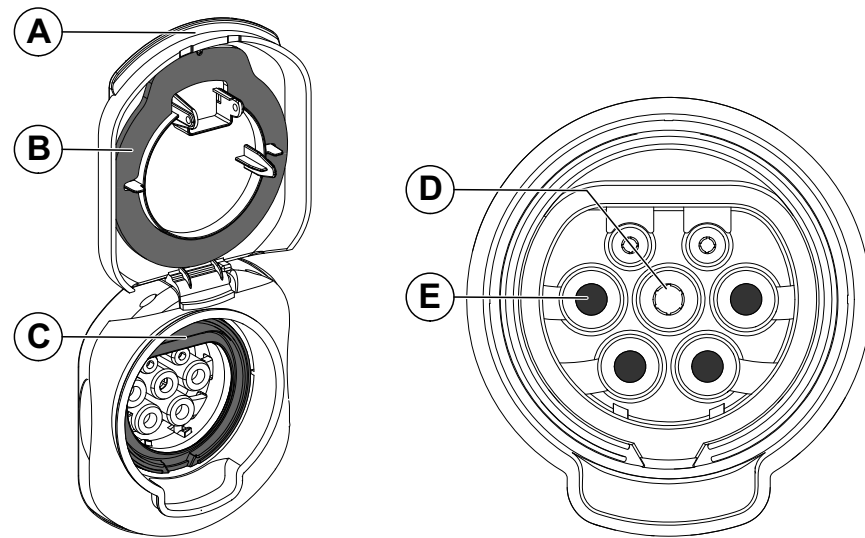

- A. Flap
- B. Flap gasket
- C. Socket gasket
- D. Earth contact
- E. Four shutters

Domestic Socket

The following graphic describes the domestic socket.

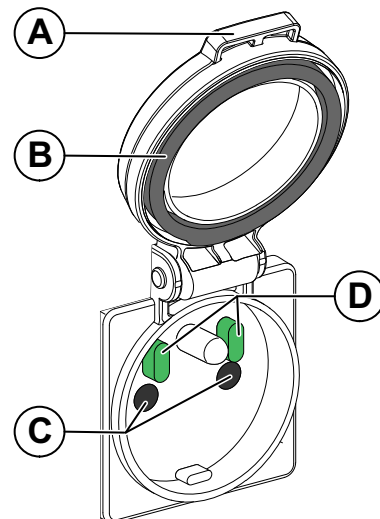

- A. Flap
- B. Flap gasket
- C. Two shutters
- D. Two sensors

Inside View



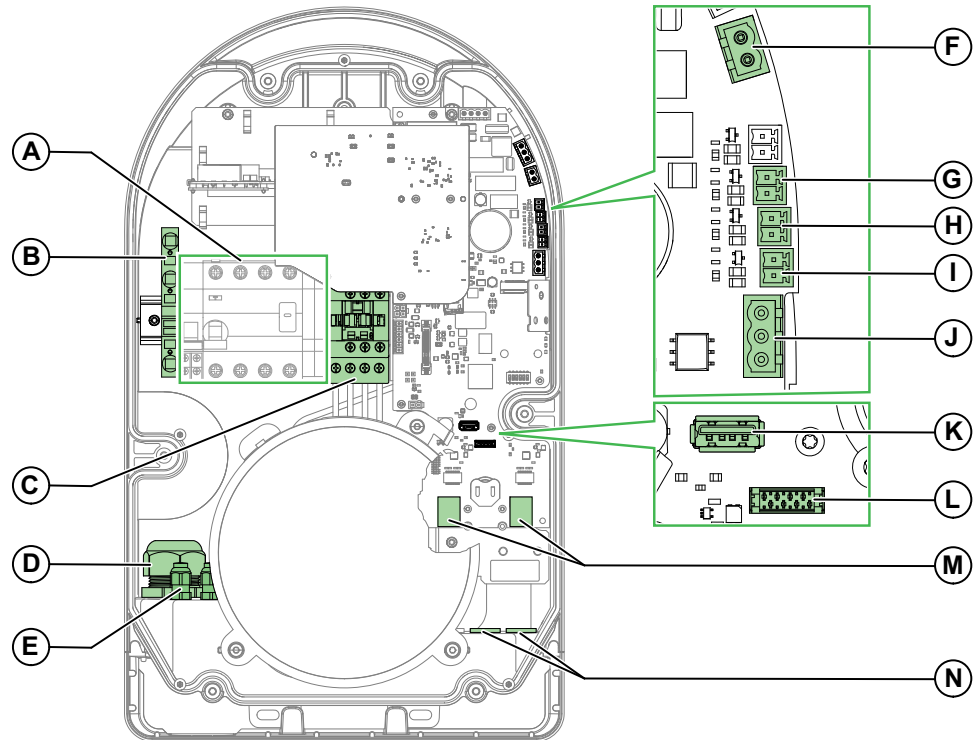











To remove the covers and access the inside of the EVlink Pro AC, refer to the *EVlink Pro AC Installation Guide* NNZ1940301.

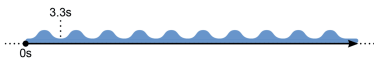

- A. Power terminal block (the representation can differ according to the models)
- B. Ground terminal block, X1
- C. Contactor
- D. Input/cable gland for power cable
- E. Cable input for connectors E1–E11
- F. Connector for under-voltage release E10 / E11
- G. Connector for E5 / E6 vehicle detection input
- H. Connector for E3 / E4 deferred start input
- I. Connector for E1 / E2 power limit input
- J. Modbus connector E7 / E8 / E9
- K. USB connector
- L. Connector for DEM (Dynamic Energy Management) function through TIC interface (optional accessory for France only)
- M. Ethernet ports ETH1 / ETH2
- N. Ethernet and DEM signal cable inputs/cable glands



Status Indicator Light

The charging station status is indicated by a LED color code, described in the following table.

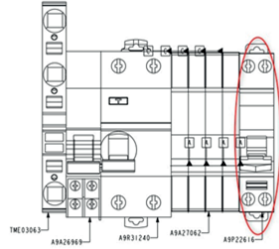

Charging station status		Type of light
Administrator status	Open Bluetooth, ready for badge recording	
Charge point status	Available	
	Unavailable or Reserved	
Communication setup status	<ul style="list-style-type: none"> Bluetooth pairing in progress: pairing success Request of the terminal location via eSetup 	 Fixed green: charge point status
	Bluetooth pairing in progress: pairing failed	 Fast blink green minimum 3 s Fast blink orange minimum 5 s Fixed green: charge point status
	Authentication in progress: authentication success	 <ul style="list-style-type: none"> Fast blink minimum 2 s Fixed green: charge point status
	Authentication in progress: authentication failed	 <ul style="list-style-type: none"> Fast blink green minimum 2 s Fixed green: charge point status
Charging status	Authentication success, waiting for EV to connect	
	Communication test between EV and charging station (deferred start)	 Blink minimum 200 ms
	EV plugged and in charge	
	EV plugged, charge interrupted to save energy or for any reason unrelated to the EV	 Blink minimum 200 ms
	EV plugged, no charge with EV	 Blink minimum 200 ms
Error	Internal error	 Blink minimum 200 ms
	EV communication error	 Blink minimum 200 ms
	Power meter communication error	 Blink minimum 200 ms
	OCCP communication error	 Blink minimum 200 ms

Electric Vehicle Troubleshooting



Electric Vehicle Does Not Charge on Domestic Socket

Indicator light	Probable cause	Solution
The indicator light is off.	The charging station is not supplied.	See EVlink Pro AC Indicator Light is Off, page 20.
The indicator light is dimming blue.	The T2S socket is used.	T2S socket takes priority. Wait the end of charging session on T2S socket.
The indicator light is green.	You are not authenticated.	Use a badge to get authenticated. If no reaction of the charging station, try with another cable and another EV. If the issue remains: <ol style="list-style-type: none"> 1. Download the diagnostic report via eSetup (see how to download the diagnostic report, page 24). 2. Contact Schneider Electric CCC and give: <ul style="list-style-type: none"> • the commercial reference of the charging station (see <i>EVlink Pro AC Identification</i>, page 11), • its industrial serial number (see <i>EVlink Pro AC Identification</i>, page 11).
The indicator light is blinking blue with two flashes every 10 s. 	The current circuit breaker (CCB) for the domestic socket has tripped.	Check the circuit breaker status:  <ul style="list-style-type: none"> • If the circuit breaker has tripped, put it on. <p>NOTE: The domestic socket maximal load value is between 6 A and 10 A, taking into account the country rule and the recorded configuration.</p> • If the issue remains: <ol style="list-style-type: none"> 1. Download the diagnostic report via eSetup (see how to download the diagnostic report, page 24). 2. Contact Schneider Electric CCC and give: <ul style="list-style-type: none"> ◦ the commercial reference of the charging station (see <i>EVlink Pro AC Identification</i>, page 11), ◦ its industrial serial number (see <i>EVlink Pro AC Identification</i>, page 11).
The indicator light is blinking blue with four flashes every 10 seconds. 	Contactors is opened after a load management (EVCE, DEM, DI, OCPP or Modbus supervision).	<ol style="list-style-type: none"> 1. In order to know the source of the load shedding, check: <ul style="list-style-type: none"> • The error code on eSetup, or • The load shedding report in the diagnostic report. 2. In case of an overload, shed other loads from the installation. 3. Check if the charging restarts.
The indicator light is red.	The charging station has detected an internal error.	See EVlink Pro AC Indicator Light is Off, page 20.

Electric Vehicle Does Not Charge on T2S Socket

Indicator light	Probable cause	Solution
The indicator light is off.	The charging station is not supplied.	See EVlink Pro AC Indicator Light is Off, page 20.
The indicator light is red.	The charging station has detected an internal error.	See EVlink Pro AC Indicator Light is Red, page 23.
The indicator light is green.	The EV cable is not well plugged in the T2S socket.	Plug the EV cable correctly in the T2S socket.
The indicator light is green.	You are not authenticated.	Use a badge to get authenticated. If no reaction of the charging station, try with another cable and another electric vehicle. If the issue remains: <ol style="list-style-type: none"> Download the diagnostic report via eSetup (see how to download the diagnostic report, page 24). Contact Schneider Electric CCC and give: <ul style="list-style-type: none"> the commercial reference of the charging station (see <i>EVlink Pro AC Identification</i>, page 11), its industrial serial number (see <i>EVlink Pro AC Identification</i>, page 11).
The indicator light is fixed orange.	The charging station is unavailable or reserved.	<ol style="list-style-type: none"> Wait for 10 minutes. Reboot the charging station. Contact your charge point operator (CPO) to check why the charging station is unavailable.
The indicator light is blinking orange.	Badge is rejected.	Add the badge to the list of authorized badges with eSetup or EVCE.
The indicator light is blinking blue with one flash every 10 seconds. 	The EV is already charged.	N/A
	The EV does not charge for EV internal management reason.	Check the EV documentation.
	The EV does not charge because the battery has a high charging threshold.	<ul style="list-style-type: none"> Check the battery charge rate. Check the EV documentation.
The indicator light is blinking blue with four flashes every 10 seconds. 	The charging station has been interrupted by a conditional input.	Check with eSetup that the Digital input is activated, and which device drives the input.
	The charging station has been interrupted by the current limitation function.	<ol style="list-style-type: none"> Check with eSetup that the current limitation is activated. Check that the current limitation threshold is correct: <ul style="list-style-type: none"> > 14 A for 3-phase charging stations, > 8 A for single-phase charging stations. Modify the current limitation threshold if necessary.
	The charging station has been interrupted by a utility smart meter.	<ol style="list-style-type: none"> Check with eSetup that the dynamic energy management (DEM) function is activated. Check the current withstand compared to the subscribed one.
	The charging station has been shed by EVCE.	<ol style="list-style-type: none"> Check the status of the charging station on EVCE. Shed other loads from the installation. Check if the charging restarts.
	Ethernet communication has been lost between EVCE and the charging station.	Check Ethernet connection LEDs on IT switch or EVCE.

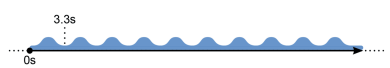
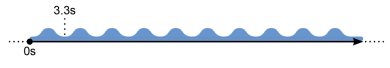
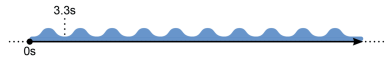
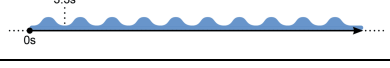
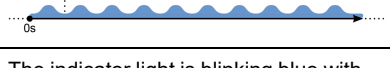
Electric Vehicle Charges Too Slowly

Indicator light	Probable cause	Solution
	The power of the charging station has been derated.	<ol style="list-style-type: none"> 1. Check that charging station status on eSetup does not allow derating. 2. Check the configuration of the DIL switch.
	The current limitation input is active.	Check that current limitation on eSetup is not active.
	The deferred charge input is active.	Check on eSetup that deferred charge input is not active.
	Dynamic energy management is active.	Check on eSetup that dynamic energy management is not active.
	The maximum current allowed on the cable is low.	Check the maximum power allowed on label of the cables.
	The power is limited by EVCE.	Check the power limitation on EVCE web page.
The indicator light is blinking blue with four flashes every 10 seconds. 	Ethernet communication has been lost between EVCE and the charging station.	<ul style="list-style-type: none"> • Download the diagnostic report via eSetup (see how to download the diagnostic report, page 24), or • Look for error code in eSetup and consult the vendor error codes, page 25.

Electric Vehicle Presence Input Does Not Work

To enable the electric vehicle presence notification through OCPP, the OCPP configuration must be on **True**. For more information, refer to *OCPP Protocol Connectivity Guide* (GEX1969200).

Probable cause	Solution
The external contact is not connected on the correct input in the charging station.	Refer to <i>EVlink Pro AC Installation Guide</i> (NNZ1940301).
The configuration in eSetup is not at the right value (normally open or normally closed).	Check with eSetup, in Configuration > Digital inputs > Vehicle detection .
The input electrical circuit is cut or in short circuit.	Contact Schneider Electric CCC.
The control in the charging station is broken.	Contact Schneider Electric CCC.

Electric Vehicle Cannot be Disconnected From T2S Socket

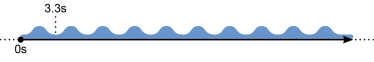
Indicator light	Probable cause	Solution
The indicator light is green.	You are not authenticated.	Use a badge to get authenticated. If no reaction of the charging station, try with another cable and another EV. If the issue remains: <ol style="list-style-type: none"> 1. Download the diagnostic report via eSetup (see how to download the diagnostic report, page 24). 2. Contact Schneider Electric CCC and give: <ul style="list-style-type: none"> • the commercial reference of the charging station (see EVlink Pro AC identification, page 11), • its industrial serial number, page 11.
The indicator light is blue. 	The EV is still charging.	Wait for the end of charging.
	The command of the lock is broken (circuit on mother board).	Contact Schneider Electric CCC.
	The lock on T2S socket is broken.	Contact Schneider Electric CCC.
	EVCE has suspended the charge.	Check the circuit breaker status: <ul style="list-style-type: none"> • If the circuit breaker has tripped, put it on. • If the issue remains: <ol style="list-style-type: none"> 1. Download the diagnostic report via eSetup (see how to download the diagnostic report, page 24). 2. Contact Schneider Electric CCC and give: <ul style="list-style-type: none"> ◦ the commercial reference of the charging station (see EVlink Pro AC Identification, page 11), ◦ its industrial serial number (see EVlink Pro AC Identification, page 11).

EVlink Pro AC Troubleshooting

EVlink Pro AC Indicator Light is Off

DANGER

HAZARD OF ELECTRIC SHOCK, EXPLOSION OR ARC FLASH

- Wear appropriate personal protective equipment (PPE) and comply with safe electrical work practices. See NFPA 70E, CSA Z462, NOM-029-STPS or local equivalent.
- This equipment must be serviced only by qualified electrical personnel.
- Perform work only after reading and understanding all of the instructions contained in this document.
- In case of work or maintenance to be performed on electric devices with the power off, respect the LOTO (Lock Out Tag Out) procedure.
- The first LOTO safety step is to prepare for shutdown: identify the equipment that requires lockout, which sources of energy must be controlled, and what lockout device to be used. Notify all affected personnel.
- The second LOTO safety step is to shutdown the equipment.
- The third LOTO safety step is to isolate the equipment from its energy source: turn off all power supplying this equipment before working inside.
- The fourth LOTO safety step is to secure isolation of the equipment: attach lock out and/or tag out devices to each energy-isolating device.
- The fifth LOTO safety step is to check the absence of voltage: any potentially hazardous stored or residual energy must be made non-hazardous.
- Always use a properly rated voltage sensing device to confirm that all power is off.
- Do not modify the mechanical or electrical parts.
- Put back all devices, doors, and covers before turning on power to this equipment.
- Beware of potential hazards, and carefully inspect the work area for tools and objects that may have been left inside the equipment.

Failure to follow these instructions will result in death or serious injury.

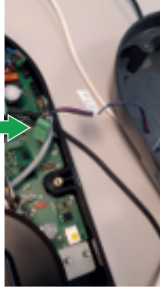
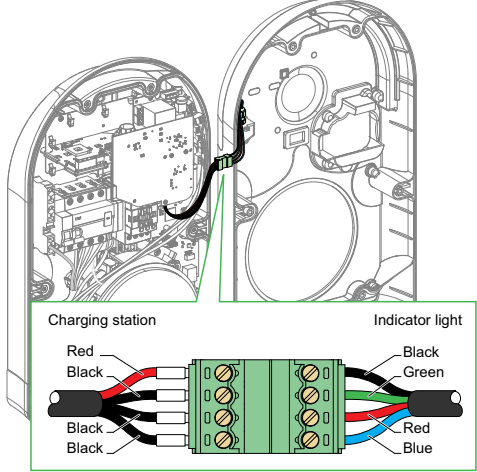

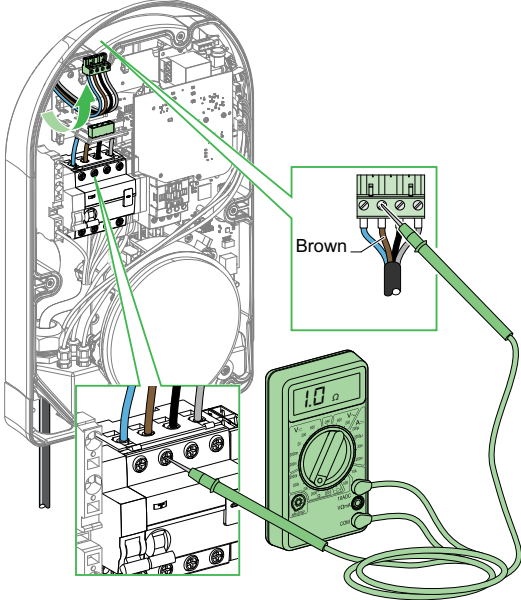
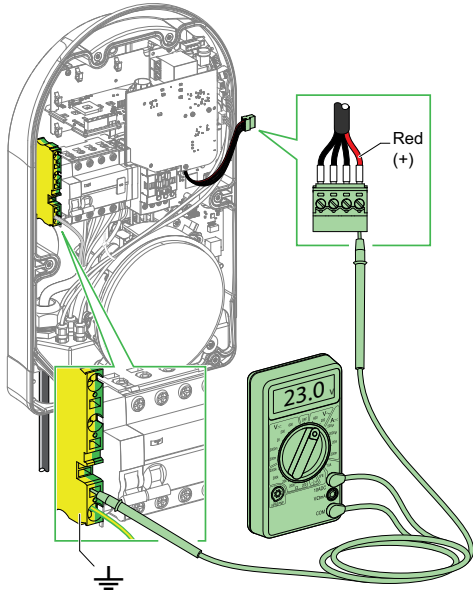

Status of internal LEDs on PCBs	Probable cause	Solution
	EVlink Pro AC is not powered because one switchgear in the distribution line is open (not tripped).	<ol style="list-style-type: none"> 1. Close all switchgear powering EVlink Pro AC in the distribution panels. 2. Check the circuit breaker and put it ON if needed.
On	<p>The indicator light connector is disconnected or in a bad wiring sequence.</p>  <p>Indicator light connector</p>	<ol style="list-style-type: none"> 1. Open the EVlink Pro AC. (see Inside View, page 14) 2. Check the indicator light connector. 3. If it is disconnected, reconnect it. 4. Check that the wires are connected in the correct sequence. 
	<p>The upstream CCB protecting the charging station has tripped due to an overcurrent.</p>	<ol style="list-style-type: none"> 1. Open the EVlink Pro AC. (see Inside View, page 14) 2. Check the upstream CCB overload setting/rating versus charging station need (discrimination between distribution panel and EVSE current rating/settings/physical derating see installation guide, refer to the <i>EVlink Pro AC - Installation Guide</i> (NNZ1940301)). <ul style="list-style-type: none"> • If the upstream CCB overload setting/rating is not correct, adjust the setting/rating and close the upstream CCB. • If the upstream CCB overload setting/rating is correct, look for any over current in the distribution line, for example, new load connected, short-circuit, cable damage.
Off	<p>The RCD protecting the charging station has tripped due to iMNx control.</p>	<p>If the RCD is connected to an iMNx, the iMNx has sent an order to open the RCD.</p> <ol style="list-style-type: none"> 1. Open the EVlink Pro AC. (see Inside View, page 14) 2. Power off/on the RCD. 3. Charge again. 4. If the iMNx trips the RCD just after closing, check the contactor and replace it if necessary. 5. If the problem is still here, see how to download the diagnostic report, page 24. 6. Contact Schneider Electric CCC and give: <ul style="list-style-type: none"> • the commercial reference of the charging station, page 11. • its serial number, page 11.
Off	<p>The RCD protecting the charging station has tripped not due to iMNx control.</p>	<p>If the RCD is not connected to an iMNx or connected to an iMNx control is not the reason for tripping, there is an abnormal leakage current.</p> <ol style="list-style-type: none"> 1. Open the EVlink Pro AC. (see Inside View, page 14) 2. Power on the RCD with EV disconnected. 3. If RCD does not trip during boot sequence, try to connect EV again: <ul style="list-style-type: none"> • If it trips again, there is a leakage in the EV. • If it does not trip again, the issue was linked to a previous vehicle. 4. If RCD trips during boot sequence, contact Schneider Electric CCC.

Status of internal LEDs on PCBs	Probable cause	Solution
On	The indicator light is defective.	<ol style="list-style-type: none"> 1. If possible, try with another indicator light (from another charging station). 2. If this is not possible, check if 24 VDC is present on the indicator light connector. 3. If 24 VDC is present, call Schneider Electric CCC to replace the indicator light.
Off	<p>The internal fuse protecting the 24 Vdc power supply is blown.</p> 	<ol style="list-style-type: none"> 1. Switch off the mains breaker. 2. Open the EVlink Pro AC. (see Inside View, page 14) 3. Check the internal fuse. 4. If the fuse is blown, contact Schneider Electric CCC. 
Off	24 VDC is not present to supply the indicator light (if mains voltage is present on input terminals and if fuse has not blown).	<ol style="list-style-type: none"> 1. Open the EVlink Pro AC. (see Inside View, page 14) 2. Check the presence of the 24 VDC on the indicator light connector.  <ol style="list-style-type: none"> 3. If 24 VDC is not present: <ul style="list-style-type: none"> • Replace it with a power supply Meanwell reference IRM-60-24ST, or • Contact Schneider Electric CCC for replacement by FSR.

EVlink Pro AC Indicator Light is Red

If you can connect to EVlink Pro AC with eSetup:

1. Go directly to the chapter *Diagnostic Report*, page 24.
2. Download a report to check the error code.
3. Follow the procedure for each error code, page 26.

Indicator light	Probable cause	Solution
 <p>One flash every 10 seconds</p>	Internal error	<ol style="list-style-type: none"> 1. Unplug the EV. 2. Power off the charging station. 3. Power on the charging station. 4. If the red indicator remains, stop using the charging station. 5. Contact the local maintenance team to download the diagnostic report via eSetup. (see how to download the diagnostic report, page 24). 6. Contact Schneider Electric CCC.
 <p>Two flashes every 10 seconds</p>	EV communication error	<ol style="list-style-type: none"> 1. Unplug the cable. 2. Plug it in again. 3. If the red indicator remains, try to use another cable, another EV, or another EV simulator. 4. Download the diagnostic report via eSetup. (see how to download the diagnostic report, page 24). 5. If the red indicator remains, contact Schneider Electric CCC.
 <p>Three flashes every 10 seconds</p>	Power meter communication error Three different option: <ul style="list-style-type: none"> • Internal power meter • External power meter (energy management/global measuring) • External power meter (dedicated to the charging station) 	Check the connection to the power meter. <ol style="list-style-type: none"> 1. If the power meter is off: <ul style="list-style-type: none"> • If the power meter is internal, contact Schneider Electric CCC. • If the power meter is external, check: <ul style="list-style-type: none"> ◦ the connection, the activity and the configuration of the RS85 connector (two wires) or the RJ45 connector ◦ the panel server, if used 2. If the red indicator remains: <ol style="list-style-type: none"> a. Download the diagnostic report via eSetup. (see how to download the diagnostic report, page 24) b. Contact Schneider Electric CCC and give: <ul style="list-style-type: none"> • the commercial reference of the power meter, • the serial number of the charging station, page 11.
 <p>Four flashes every 10 seconds</p>	OCPP communication error	If EVCE is present: <ol style="list-style-type: none"> 1. Check that the EVCE device is on. 2. Check the EVCE dashboard. 3. Check the IT infrastructure between EVCE and EVSE (including routing devices). 4. If the charging station is connected to supervision: <ol style="list-style-type: none"> a. Check that the model is on. b. In case of wireless modem, check the signal strength. c. Check the IT infrastructure between the modem and EVSE (including routing devices). 5. If the issue remains, download the diagnostic report via eSetup. (see how to download the diagnostic report, page 24) and contact Schneider Electric CCC.

Diagnostic Report

Description

The diagnostic report indicates important information for Schneider Electric Customer Care Center to assess the issue (configuration problem, troubleshooting, random or permanent issue). It is recommended to download a diagnostic report at the beginning of any troubleshooting intervention and to have the log just after the issue appears.

There are 3 types of error indications:

- Error: the charge is stopped, and the indicator light of the charging station is red.
- Warning: there is an error, and the charging station creates a log, but the charging does not stop.
- Functional log: only information for Schneider Electric, and the charging does not stop.

The diagnostic report gives the following general information:

- Product information
- Network
- Configuration
- Charge management
- Software versions

How to Download the Diagnostic Report

You can download the diagnostic report with the 2 following methods:

- Opening eSetup application on your smartphone (Refer to the video *How to diagnose an EVlink Pro AC issue with eSetup.*) :

1. Click on **Get the complete diagnostic report > Export and protect with password**



2. Save the diagnostic report on your smartphone.

- Using the EV Charging Expert. Refer to the *EcoStruxure™ EV Charging Expert User Guide* (DOCA0163).

Vendor Error Codes

Error codes can be raised by the charging station. These error codes can be found on eSetup.

To find the error code:

1. Select the charging station status **Faulted**.
eSetup displays the charging station status.
2. The active error code is indicated. Select the information logo close to the error code to get the meaning of this code.
eSetup displays the error description.

The table below details the error codes that can be raised by the charging station.

Error code, page for the corresponding procedure	Generic error name	Specific error name	Error description
1.0, page 26	Software Configuration	Capacity out of range	Bad configuration of the microswitch.
1.1		Firmware downgrade	Charging station detects that the software version is lower than expected.
1.2		Software downgrade	Charging station detects that the software version is lower than expected.
2.0, page 26	Hardware Configuration	Mother board issue	Issue with EVSE hardware.
2.1, page 26		Physical derating issue	Invalid physical derating configuration OR change of physical derating configuration during charge. Configure the microswitch according to the Installation Sheet.
2.2		Plug issue 6 mA	6 mA plug missing.
2.3		Plug issue 15118	15118 plug missing.
2.4		Front cover opened	Front cover opened.
2.5		Issue on temperature Sensor	Issue with the temperature sensor. Only for Eichrecht commercial references.
3.0, page 26	Upstream Protection Devices	MNX tripping	Trip of MNX / Contactor discordance.
4.0, page 26	RDC_DD	RDC DD (6 mA) measurement board error	RDC DD internal device reports an internal error.
5.0, page 26	6mA_Detection	6mA DC leakage detected	DC leakage value higher than 6 mA.
6.0, page 27	Metering	Input voltage issue	Phase synchronization defect or input voltage or frequency error.
6.1, page 27		Internal Metering card issue	At least one metering fault has been detected.
7.0, page 27	PowerMeter	Internal Power Meter communication loss	Loss of communication with Modbus power meter for metering (either internal or external), for 3 consecutive unsuccessful attempts.
7.1		Dataset issue	Verification of the dataset signature failed or Others dataset error.
8.0, page 27	Bluetooth	Bluetooth communication issue	Issue with Bluetooth processor: communication lost or update impossible.
9.0, page 27	Badge reader	Badge reader issue	Loss of communication with the RFID, NFC reader.
10.0	EV_ISSUES	EV issue : Control Pilot (CP)	Communication fault with a Mode 3 / T2 vehicle ("CP" error: Control Pilot).
10.1		Plug Presence (PP) conformity	Cable status wrong (the value of the coding resistor "PP" is wrong).
10.2		EV issue : Short-circuit CPW	Charging fault short-circuit on Control Pilot Wire.
11.0, page 27	Outlet	Lock/Unlock cable Failure	Wrong handling during the plug/unplug of the socket, or motor blocked.

Error code, page for the corresponding procedure	Generic error name	Specific error name	Error description
12.0, page 27	Contactor	Contactor Discordance	Contactor is not in the requested state: welded or blocked in open position.
13.0, page 27	Phase_discordance	Load three-phase compliancy	Three phases charging not allowed in simplified mode 3.
14.0, page 27	Overcurrent	EV Overcurrent	Overcurrent or overload charging fault due to EV.
15.0, page 27	VENTILATION_NOT_ALLOWED	Ventilation Not Allowed	Battery gas leakage risk. Car asking ventilation that is not compatible with our products.
16.0, page 27	EVCE	EVCE communication loss	Supervision communication lost between EV Charging Expert and the charging station.
17.0, page 27	OCPP	Supervision (OCPP) issue	Communication or configuration of Supervision (OCPP) issue.
17.1, page 27	OCPP	CPO communication lost	The communication between the charge point operator (CPO) and the charging station is lost but the Charging station is not in error. Load is authorized when offline.
18.0, page 28	EM	Dynamic Energy management communication loss : TIC	Communication lost with external device for energy management (TIC).
18.1, page 28		Dynamic Energy management communication loss : Modbus meter	Communication lost with external device for energy management (Modbus meter).
19.0	Temperature	Temperature out of the authorized range	Temperature too high or too low. Only for Eichrecht commercial references.

Procedure for Each Error Code

The following table indicates the procedure to follow for each error code.

Error code	Solution
1.0	Check in eSetup that eSetup configuration does not allow derating. Check the configuration of the DIL switch (see description in <i>EVlink Pro AC - Installation Guide</i> (NNZ1940301)).
1.1, 1.2	Check the software version.
2.0	<ol style="list-style-type: none"> 1. Save the diagnostic report. 2. If there is a cord connected, disconnect the cord and restart the charging station. 3. If the error code remains, contact Schneider Electric CCC.
2.1	<ol style="list-style-type: none"> 1. Configure the microswitch (see description in <i>EVlink Pro AC - Installation Guide</i> (NNZ1940301)). 2. If the error code remains, contact Schneider Electric CCC.
3.0	<ul style="list-style-type: none"> • For EVlink Pro AC with MR part number, check the type of default on eSetup. • For other EVlink Pro AC charging stations: <ol style="list-style-type: none"> 1. Check if MNx has tripped. 2. If contactor is in on position: <ul style="list-style-type: none"> ◦ Replace the contactor, or ◦ Contact Schneider Electric CCC.
4.0	<ol style="list-style-type: none"> 1. Unplug the EV. 2. Power off the charging station. 3. Power on the charging station. 4. If the error code remains, stop using the charging station and contact Schneider Electric CCC.
5.0	If this error occurs during EV charge: <ol style="list-style-type: none"> 1. Unplug the connection to the EV. 2. Check that the EVlink Pro AC indicator light is green. 3. Contact Schneider Electric CCC.

Error code	Solution
6.0	For EVlink Pro AC: <ul style="list-style-type: none"> With RCD embedded, check in eSetup that phases connection is set on three-phase. Without RCD embedded, check in eSetup that phases connection is set on single-phase
6.1	<ol style="list-style-type: none"> Switch off the charging station. Switch it again. If the error code remains, change the charging station.
7.0	<ol style="list-style-type: none"> Check if there is information on MID power meter display. Contact Schneider Electric CCC.
8.0	<ol style="list-style-type: none"> Check FAQ on se.com on to fix the issue. If the error code remains, contact Schneider Electric CCC.
9.0	<ol style="list-style-type: none"> Restart the charging station. Present a badge in front of the charging station. If the error code remains, contact Schneider Electric CCC.
10.0, 10.1, 10.2	<ul style="list-style-type: none"> If you have an EV simulator, try to use the charging station with an EV simulator: <ul style="list-style-type: none"> If the error code disappears, try with another cable or another EV. If the error code remains, contact Schneider Electric CCC. If you do not have an EV simulator: <ol style="list-style-type: none"> Unplug the cable. Plug the cable again. If the error code remains, contact Schneider Electric CCC.
11.0	<ul style="list-style-type: none"> If the error code is displayed when the cable is not connected, restart the charging station. If the error code is displayed when the cable is connected: <ol style="list-style-type: none"> Unplug the cable. Plug the cable again. If the error code remains, replace the cable. If the error code remains, contact Schneider Electric CCC.
12.0	<ol style="list-style-type: none"> Turn off the charging station. Check if the contactor opens and closes properly. If the contactor opens and closes properly: <ul style="list-style-type: none"> Replace the charging station, or Contact the Field Service Representative.
13.0	EV is not compliant with the IEC 61851 ed 3 and with the charging station.
14.0	<ol style="list-style-type: none"> Try using the charging station with another EV: <ul style="list-style-type: none"> If the error code disappears, the problem was due to the previous EV. If the error code remains, the charging station needs to be replaced. Contact Schneider Electric CCC.
15.0	EV ventilation system is not compliant with EVlink Pro AC charging station.
16.0	<ol style="list-style-type: none"> Check that the EVCE device is on. Check the EVCE dashboard. Refer to the EVCE troubleshooting guide. Check the IT infrastructure between EVCE and EVSE (including routing devices).
17.0	<ol style="list-style-type: none"> Check the Ethernet connection. Check the response to the ping test of the IP address of the charging station. Check that the configuration parameters for supervision are correct. If a modem is present, check that the modem parameters are correct. If the error code remains, see how to download the diagnostic report via eSetup, page 24, and contact Schneider Electric CCC.
17.1	<ol style="list-style-type: none"> Check that the modem, the router and the IT switch are on. Check the IT infrastructure. In case of wireless modem, check the signal strength.

Error code	Solution
18.0	<ol style="list-style-type: none"><li data-bbox="352 174 815 203">1. Check that the TIC communication LED is on.<li data-bbox="352 208 1161 237">2. If the LED is off, check the wires between the charging station and the Linky meter.
18.1	<ol style="list-style-type: none"><li data-bbox="352 257 1398 309">1. Check that the communication parameters between the charging station and the power metering device are correct.<li data-bbox="352 313 762 342">2. Check that the external wiring is correct.<li data-bbox="352 347 826 376">3. If necessary, replace the external power meter.<li data-bbox="352 380 1062 409">4. If external power meter is working properly, replace the charging station.

eSetup Troubleshooting

eSetup Presentation

eSetup application helps you to configure the Pro AC charging stations and to diagnose potential problems using Pro AC charging stations.

eSetup for electricians is an application that can be downloaded on Google Store and Apple Store.

Charging Station Configuration With eSetup

For the charging station configuration, follow the instructions of the *EVlink Pro AC Installation Guide* (NNZ1940301) and refer to the video showing how to commission EVlink Pro AC Charging Station with eSetup.

Add User Badges

To add badges, refer to *EVlink Pro AC Installation Guide* (NNZ1940301) and refer to the video showing how to commission EVlink Pro AC Charging Station with eSetup.

Connection to the Charging Station

Prerequisites for Using Bluetooth Communication

The prerequisites for using a Bluetooth communication are:

- The charging station light indication must be green, indicating that the charging station is powered, with Bluetooth communication activated. If the light indication is not green, see *status light indicator*, page 15.
- You must have a smartphone running the eSetup application.
- The smartphone must support Android 4.4 or iOS 9 or above, and be compatible with Bluetooth wireless technology.
- You must have access to the charging station, and be physically within an open field range of 15 meters for the duration of the connection.

Establishing a Bluetooth Connection

Follow the procedure below to establish a Bluetooth connection from your smartphone to the charging station.

1. Start eSetup application on your smartphone.
2. Tap the admin badge on the RFID reader of the charging station. See *exterior view of the charging station*.

Result: the Bluetooth connection is established. The connection closes automatically two hours after the closing of an eSetup configuration session.

3. Enter the PIN code (six digits).

I Cannot See the Charging Station on eSetup

Probable cause	Solution
Bluetooth communication is not activated on the charging station.	<ul style="list-style-type: none"> If the admin badge was never created, reboot the charging station. Result: you have two hours with Bluetooth activated. If you have an admin badge created, scan it. Result: you have 10 minutes with Bluetooth activated.
Bluetooth communication is not activated on the smartphone or tablet.	Check your device.
The charging station is connected to eSetup of another user.	Check if another user around 20 meters of the charging station is connected to it.
You are too far from the charging station.	Go closer to the charging station.
You are on demo mode on eSetup.	Deactivate demo mode on eSetup.
The charging station is out of order.	<p>If the EVlink Pro AC indicator light is off, see the chapter <i>EVlink Pro AC Troubleshooting</i>, page 20.</p> <p>If the EVlink Pro AC indicator light is red, see the chapter <i>EVlink Pro AC Troubleshooting</i>, page 23.</p>
The charging station has already been configured by another user.	Reactivate the Bluetooth connection with an admin badge. See how to establish a Bluetooth connection, page 29.
Physical derating configuration is invalid or physical derating configuration has been changed during charge.	<ol style="list-style-type: none"> Configure the microswitch according to the <i>EVlink Pro AC Installation Guide</i> (NNZ1940301). If the problem is not on the microswitch, change the charging station.
You are using an Android version lower than 12.	Activate the localization function.

I Have a Problem With the Password

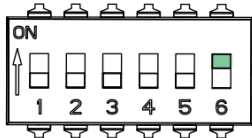
Probable cause	Solution												
You have forgotten the password.	<p>Reset the PIN code. Refer to the <i>EVlink Pro AC Installation Guide</i> (NNZ1940301).</p> 												
You have the wrong PIN code.	Recover the correct PIN code or reset the PIN code.												
You have entered several wrong PIN codes.	<p>Wait the end of time out after several wrong PIN codes, or reset the PIN code.</p> <table border="1"> <thead> <tr> <th>Number of failed attempts</th> <th>Next allowed login attempt</th> </tr> </thead> <tbody> <tr> <td>< 3</td> <td>Now</td> </tr> <tr> <td>3</td> <td>Now + 5 minutes</td> </tr> <tr> <td>4</td> <td>Now + 15 minutes</td> </tr> <tr> <td>5</td> <td>Now + 30 minutes</td> </tr> <tr> <td>> 5</td> <td>Now + 60 minutes</td> </tr> </tbody> </table>	Number of failed attempts	Next allowed login attempt	< 3	Now	3	Now + 5 minutes	4	Now + 15 minutes	5	Now + 30 minutes	> 5	Now + 60 minutes
Number of failed attempts	Next allowed login attempt												
< 3	Now												
3	Now + 5 minutes												
4	Now + 15 minutes												
5	Now + 30 minutes												
> 5	Now + 60 minutes												

I Have a Problem With the Admin Badge

Indicator light	Probable cause	Solution
Orange blinking	Your admin badge is not recorded.	<ol style="list-style-type: none"> 1. Reboot the charging station. You have two hours with Bluetooth activated. 2. Connect on eSetup with the charging station. 3. Create your admin badge.
No light change when you scan the badge	Your admin badge is broken.	<ol style="list-style-type: none"> 1. Try the badge with a smartphone application or with another charging station. 2. If it still does not work, take another badge.
Red	The RFID reader of the charging station is broken. See exterior view of the charging station.	<ul style="list-style-type: none"> • Download the diagnostic report via eSetup (see how to download the diagnostic report), or • Look for error code in eSetup and consult the vendor error codes, page 25.

I Cannot Record Badges With eSetup

Indicator light	Probable cause	Solution
No reaction or orange blinking	Badge is not compliant with EVlink RFID reader.	<ol style="list-style-type: none"> 1. To determine the standard of your badge, scan it with smartphone application. 2. Compare your badge with our list of compliant badge standards.
Red light	The RFID reader of the charging station is broken. See exterior view of the charging station.	<ul style="list-style-type: none"> • Download the diagnostic report via eSetup (see how to download the diagnostic report, page 24), or • Look for error code in eSetup and consult the vendor error codes, page 25.

I Have a Problem With the User Badge

Indicator light	Probable cause	Solution
Orange blinking	Your user badge is not recorded.	Record your badge in the charging station (see the chapter <i>EVlink Pro AC Troubleshooting</i> , page 20).
Orange blinking	Charge started with another badge and the charging station is configured in lock in public environment.	Use the same badge as the one which initiated the charging cycle.
Orange blinking	Supervision is out of service and offline mode is only badge in the cache list .	You need a badge that already charged once with supervision online.
Red	Supervision is out of service and offline mode is all badges rejected .	<ul style="list-style-type: none"> • Download the diagnostic report via eSetup (see how to download the diagnostic report, page 24), or • Look for error code in eSetup and consult the vendor error codes, page 25.
No light change when you scan the badge	Your user badge is broken.	<ol style="list-style-type: none"> 1. Try the badge with a smartphone application or with another charging station. 2. If it still does not work, take another badge.
Red	The RFID reader of the charging station is broken. See the exterior view of the charging station.	<ul style="list-style-type: none"> • Download the diagnostic report via eSetup (see how to download the diagnostic report, page 24), or • Look for error code in eSetup and consult the vendor error codes, page 25.

Glossary

C

CCB: Current circuit breaker

CCC: Customer Care Center

CPO: Charge point operator

D

DEM: Dynamic Energy Management

Diagnostic report: Contains important information for Schneider Electric Customer Care Center to assess the issue with the EVlink Pro AC charging station.

E

EVCE: Electric Vehicle Charging Expert. Electric vehicle charging infrastructure load management, access management and supervision solution. Formerly known as EVlink Load Management System.

EV: Electric vehicle

EVSE: Electric Vehicle Supply Equipment. Electric vehicle charging station and equipment necessary to charge the electric vehicle.

O

OCPP: Open Charge Point Protocol. An application protocol for communication between electric vehicle charging stations and a central management system, also known as a charging station network, similar to cell phones and cell phone networks.

R

RCD: Residual Current Device. Safety device that switches off electricity automatically if there is a fault.

T

TIC: Tele-information customer

Printed in:
Schneider Electric
35 rue Joseph Monier
92500 Rueil Malmaison - France
+ 33 (0) 1 41 29 70 00

Schneider Electric
35 rue Joseph Monier
92500 Rueil Malmaison
France

+ 33 (0) 1 41 29 70 00

www.se.com

As standards, specifications, and design change from time to time,
please ask for confirmation of the information given in this publication.

© 2023 Schneider Electric. All rights reserved.

DOCA0282EN-00